

Section 2.2 : Electro- mechanical analogies

PHILIPPE HERZOG AND GUILLAUME PENELET

Table des matières



I - Introduction	5
A. Objective.....	5
B. Test your knowledge.....	5
C. Context.....	7
II - Elementary phenomena	9
A. Mechanical elements.....	9
1. Mechanical elements.....	9
2. Inertia of an object.....	9
3. Deformation of an object.....	10
4. Damping.....	10
5. Mechanical lever.....	10
III - Electro-mechanical analogies	13
A. Electro-mechanical analogies.....	13
B. Direct analogy.....	13
1. Direct Analogy.....	13
2. Direct analogy of mechanical elements.....	14
C. Indirect analogy.....	14
1. Indirect analogy.....	14
2. Indirect analogy of mechanical elements.....	15
D. Simple mechanical system.....	16
1. A simple mechanical system.....	16
2. External force applied to a "mass-spring" system (1/2).....	16
3. External force applied to a "mass-spring" system (2/2).....	16
E. Analogy comparison.....	17
1. Mass-spring system by the direct analogy (impedance).....	17
2. Mass-spring system by the indirect analogy (mobility).....	17
3. Mechanical impedance.....	17
4. Mobility (Mechanical admittance).....	18
5. Choice of an analogy.....	19

IV - Equivalent network of a system	21
A. Applications, example of a 2DoF (two degrees of freedom) system.....	21
B. Real system: Electrodynamic loudspeaker driver.....	21
C. Mechanical system.....	22
D. Direct approach: mechanical description.....	23
E. Direct approach: regrouping the terms.....	23
F. Direct approach: mechanical electrical analogy (1/2).....	23
G. Direct approach: mechanical electrical analogy (2/2).....	24
H. Mobility method: principle.....	24
I. Mobility method: mechanical schematic.....	25
J. Mobility method: conversion to the indirect analogy.....	25
K. Mobility method: conversion into a dual schematic.....	26
V - Conclusion	27
A. Exit test.....	27
B. Exit test: answer.....	28
C. Bibliography.....	28

Introduction

Objective	5
Test your knowledge	5
Context	7

A. Objective

Objective

The objective of this section is to identify the main phenomena in vibrating mechanical systems, and make an equivalent electrical network.

Pre-required notions

- Basic notions of Newtonian mechanics (in French):
<http://numeliphy.unisciel.fr/consultation/liste/module/mecanique1>¹
- Basic notions in electricity.
(*section 2.1*²)

B. Test your knowledge

Exercice 1 : Exercise 1 - Entrance test

Question 1

What is a degree of freedom (in mechanics)?

- The possibility of non hindered movement (translation or rotation) for the considered mechanical system.
- It's the freedom the mechanic has to pick the reference point.
- It does not exist

1 - <http://numeliphy.unisciel.fr/consultation/liste/module/mecanique1>

2 - [../Grain2.1en/index.html](http://numeliphy.unisciel.fr/consultation/liste/module/mecanique1)

Question 2

How many degrees of freedom does the following system have?

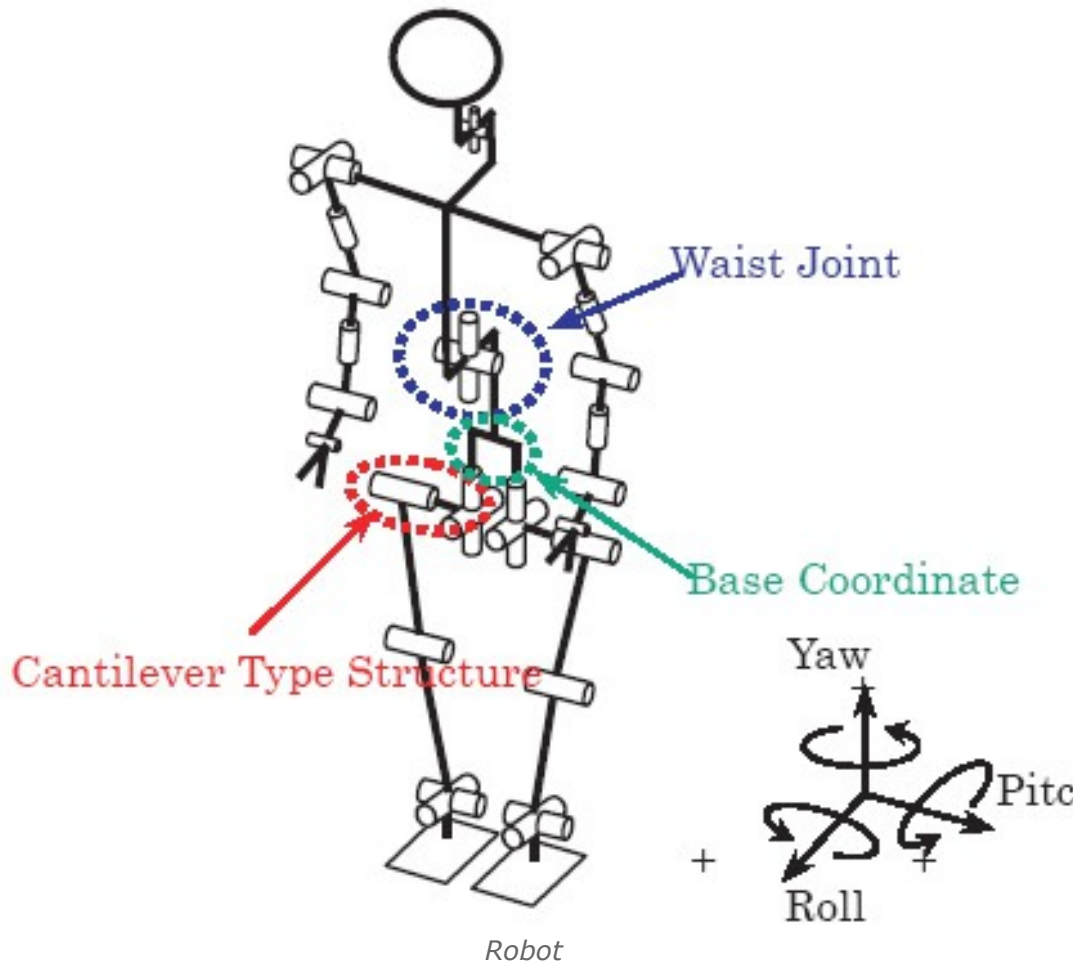

- 30
- 6
- an infinite amount

Question 3

What is an oscillator (in mechanics)?

- It's a compressible system, of finite and non zero mass
- It's a system with at least one resonance.
- It is a system that may vary around a stable point of equilibrium.

Question 4

What is the "resonance" of a single degree of freedom mechanical system?

- The aptitude of the system to accumulate energy at a particular frequency (said resonance frequency)
- The aptitude of the system to stock energy at a particular frequency (said resonance frequency)
- The aptitude of the system to dissipate energy at a particular frequency (said resonance frequency)

C. Context

Analogies of objects

Lots of mechanical systems can be approximated by a finite number of discrete mechanical elements.

By separating the main mechanical phenomena, it is thereby possible to represent them by perfect masses, springs and dampers.

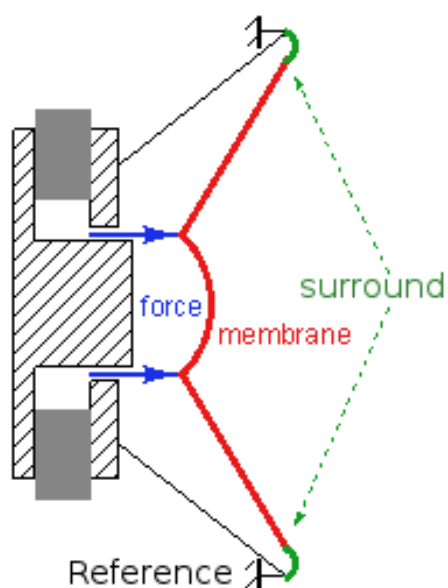

The examples that illustrate this lecture are limited to translational movements, but the same approach will work for multiple translations and rotations.

Elementary phenomena

A. Mechanical elements

1. Mechanical elements

Using basic elements we will now represent the main phenomena in mechanical systems:

- the inertia of a mass,
- the deformation of an elastic object,
- the dissipation by friction,
- the transformation by a lever.

2. Inertia of an object

Rigid point particle

The net force F of exterior forces applied to a body will create acceleration.

The inertia linked to its mass M is proportional to this acceleration, expressed in an inertial frame of reference.

Fundamental Principle of Dynamics

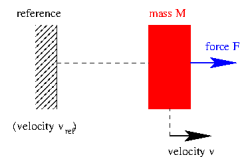
	$F(t) = M \frac{d}{dt}(v(t) - v_{ref})$ $F = j\omega M(v - v_{ref})$
---	--

- In this lecture, the reference frame (mechanical reference frame) is stationary: $v_{ref} = 0$.
- The mass inertia corresponds to the system's kinetic energy.

3. Deformation of an object

Linear axial compliance without mass

The net force F of the exterior forces applied to an elastic object (here without mass) will result in a deformation of the object.

Behavioural law

	$F(t) = \frac{1}{C}(\xi_2(t) - \xi_1(t))$ $= \frac{1}{C} \int (v_2(t) - v_1(t))dt$ $F = \frac{1}{j\omega C}(v_2 - v_1)$
--	---

- In linear elasticity, the deformation $(\xi_2 - \xi_1)$ is proportional to the applied force.
- In this lecture, the elasticity is expressed by its compliance C , instead of its stiffness $K = 1/C$.
- Elastic deformation corresponds to a "stocking" of potential energy.

4. Damping

Linear damper ("dashpot")

The net force F of the exterior forces applied to an object without stiffness and mass can result in a deformation. The reaction of the object to this deformation is therefore dissipative.

Behavioural law

	$F(t) = R(v_2(t) - v_1(t))$ $F = R(v_2 - v_1)$
--	--

- The deformation speed $(v_2 - v_1)$ is here proportional to F .
- It expresses a irreversible transformation linked to the linear viscosity.

5. Mechanical lever

Ideal mechanism (loss less)

A lever is an example of an ideal mechanism linking two mechanical quantities (F_1, v_1) and (F_2, v_2) .

Coupling equations

	$F_1 \ell_1 = F_2 \ell_2$ $\frac{v_1}{\ell_1} = \frac{v_2}{\ell_2}$
--	---

- The lever plays the role of a transformer: $\frac{F_1}{v_1} = \left(\frac{\ell_2}{\ell_1}\right)^2 \frac{F_2}{v_2}$.
- This ideal transformation conserves energy.

Electro-mechanical analogies

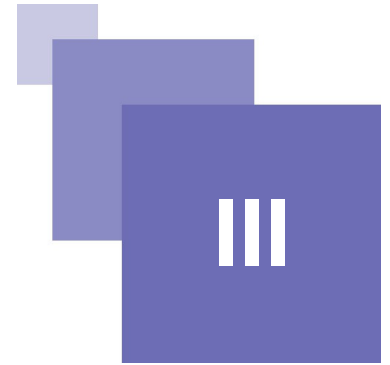

Electro-mechanical analogies	13
Direct analogy	13
Indirect analogy	14
Simple mechanical system	16
Analogy comparison	17

A. Electro-mechanical analogies

We will now represent the phenomena existing in mechanical systems, by an equivalent electrical network. This introduces analogies between the two forms of energy, which can be expressed in two ways:

- the direct analogy (impedances),
- the indirect analogy (mobility).

B. Direct analogy

1. Direct Analogy

Conventionally, the "direct" analogy consists in associating the mechanical speed of a mass, with the electrical current (which can be considered as the volume velocity of electrical charges through a conductor).

From an energetic point of view, this consists of associating the kinetic energy of a mechanical system with a similar form of energy in the equivalent electrical system. The same reasoning shows that the potential energy stocked in the deformation of a mechanical element is represented by the energy stocked in a capacitor under the influence of a voltage drop.

The "direct" analogy therefore associates an electrical impedance with a mechanical one: it is sometimes called the "impedance analogy".

2. Direct analogy of mechanical elements

Inertia

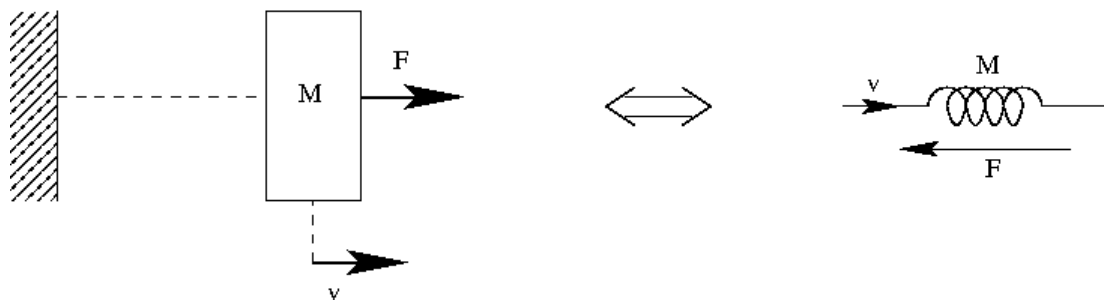

Compliance

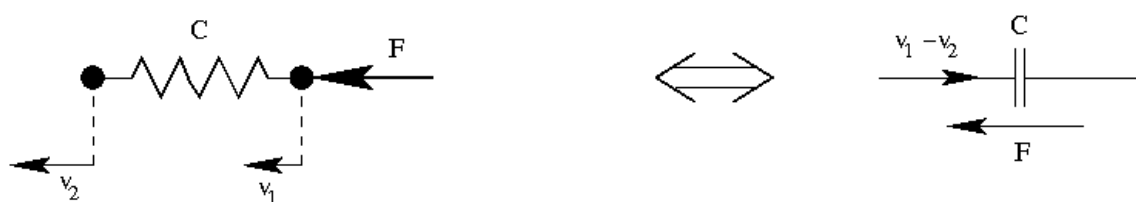

Damping

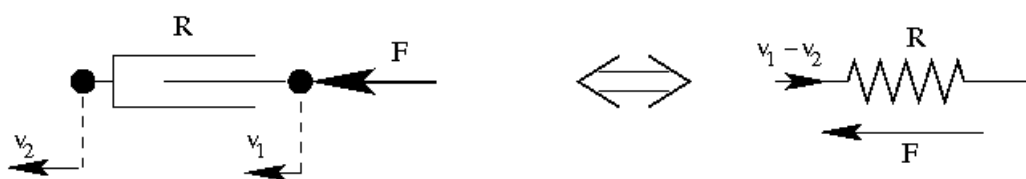

Lever

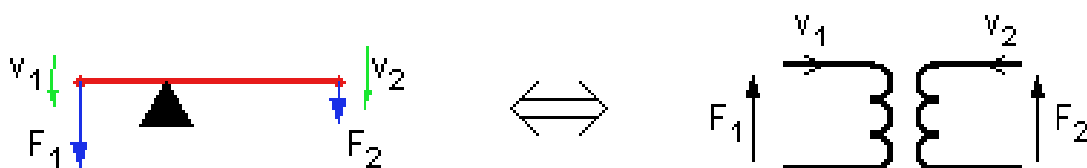

C. Indirect analogy

1. Indirect analogy

Conventionally, the "indirect" analogy consists in associating the mechanical speed of a mass, with the electrical voltage.

From an energetic point of view, this consists in representing the kinetic energy of a mechanical system as a potential energy stocked in a capacitor.

The same reasoning shows that the potential energy stocked in the deformation of a mechanical element is represented by the energy stocked in an inductor under the influence of the current flowing through it.

The "indirect" analogy therefore associates an electrical admittance with a mechanical impedance: it is sometimes called "mobility analogy".

The representation of the damping and lever are the same for both analogies. The difference is that the roles of force and speed are reversed.

2. Indirect analogy of mechanical elements

Inertia

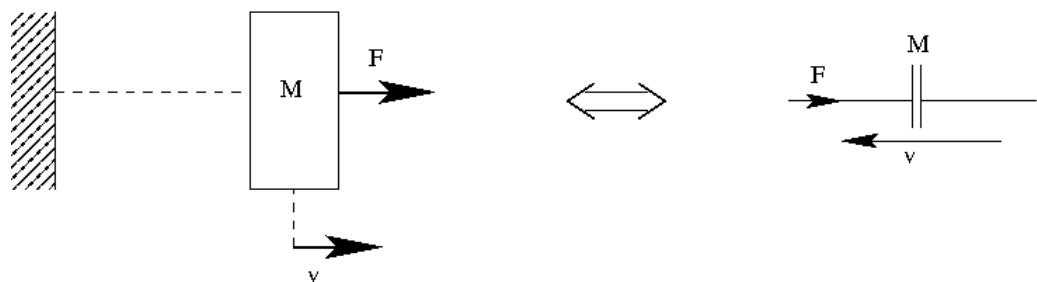

Compliance



Damping

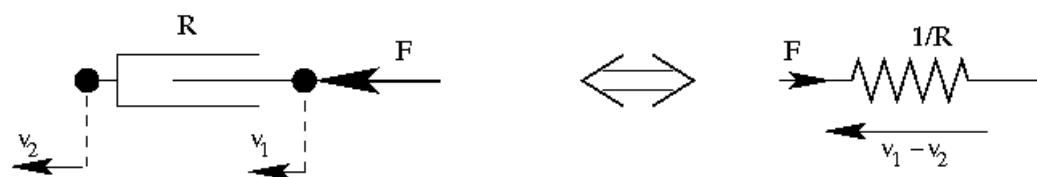

Lever

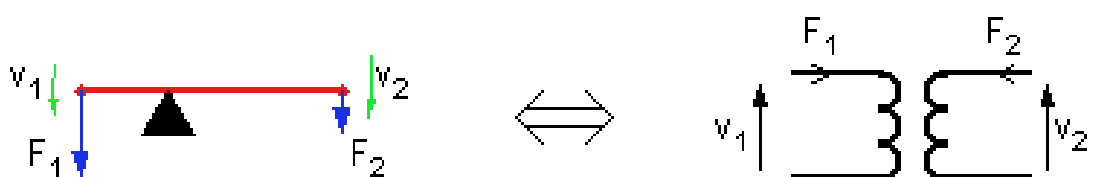

D. Simple mechanical system

1. A simple mechanical system

We will now illustrate the electro-mechanical analogies by establishing the mechanical schematic of a simple system, the "mass-spring" system, then creating the two equivalent electrical circuits using the two analogies.

2. External force applied to a "mass-spring" system (1/2)

If we consider the mechanical system illustrated in the figure below, which consists of an external operator applying a force on a mass-spring system.

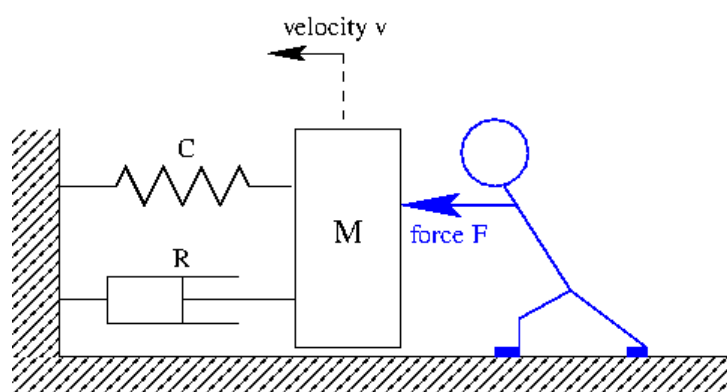

This system is therefore described by a single degree of freedom (SDF), the speed $(v - v_{ref})$, and is subjected to the net force F , to which it opposes its reaction.

3. External force applied to a "mass-spring" system (2/2)

The assessment of the exterior forces leads to the establishment of the following movement equations:

$$F(t) - \frac{1}{C}(\xi(t) - \xi_{ref}) - R(v(t) - v_{ref}) = M\partial_t(v(t) - v_{ref}),$$

or, in the harmonic domain:

$$F - \frac{1}{jC\omega}(v - v_{ref}) - R(v - v_{ref}) = j\omega M(v - v_{ref}).$$

In considering that the cause is the applied force, and the effect is the movement of the mass, it is normal in mechanics to consider that **it is the speed v which expresses a degree of freedom.**

E. Analogy comparison

1. Mass-spring system by the direct analogy (impedance)

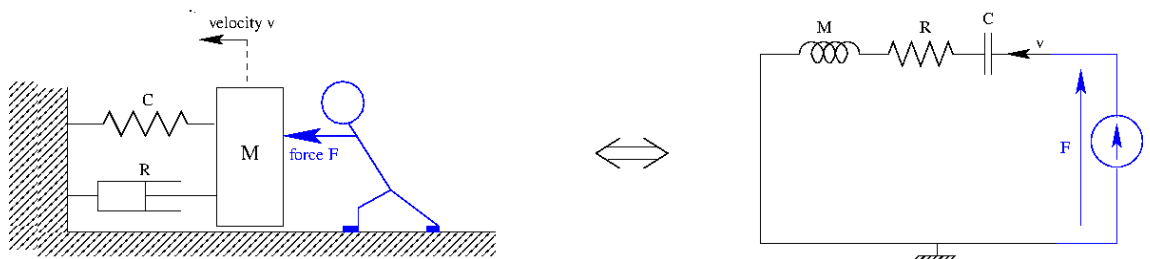

- The action of a mechanical force corresponds to the action of a electrical voltage generator.
- The resulting speed, identical for the three mechanical elements, corresponds to the electrical current flowing through the three electrical elements.
- The structure of the electrical circuit is not the same as the mechanical schematic.

2. Mass-spring system by the indirect analogy (mobility)

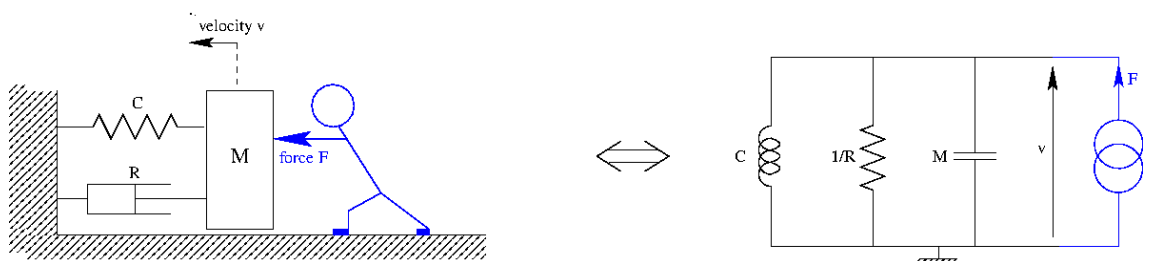

- The action of a mechanical force corresponds to the action of an electrical current generator.
- The resulting speed, identical for each mechanical element, corresponds to the voltage drop across the three electrical elements.
- The structure of the electrical circuit is similar to that of the mechanical schematic.

3. Mechanical impedance

$$Z = \frac{F}{v} = \left[\frac{1}{j\omega C} + R + j\omega M \right] = \frac{\left[1 - \left(\frac{\omega}{\omega_0} \right)^2 + j \frac{\omega}{Q\omega_0} \right]}{j\omega C} \quad \text{with} \quad \omega_0 = \frac{1}{\sqrt{MC}} \quad \text{and} \quad Q = \frac{M\omega_0}{R}$$

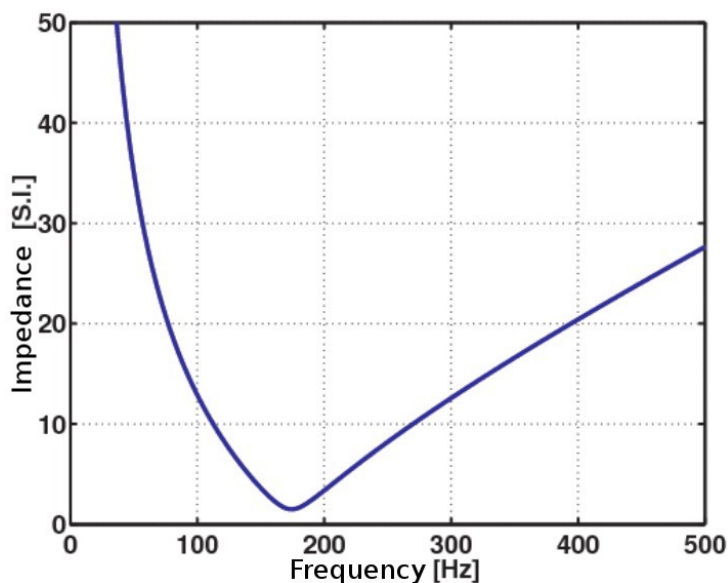

At resonance, the mechanical system's reaction is maximum (near to its resonance frequency $f_0 = \frac{1}{2\pi\sqrt{MC}}$), this corresponds to a minimum of the impedance Z : this quantity does not therefore intuitively represent the system.

4. Mobility (Mechanical admittance)

$$Y = \frac{v}{F} = \frac{j\omega C}{[1 - \omega^2(MC) + j\omega(RC)]} = \frac{j\omega C}{[1 - (\frac{\omega}{\omega_0})^2 + j\frac{\omega}{Q\omega_0}]}$$

with $\omega_0 = \frac{1}{\sqrt{MC}}$ et

$$Q = \frac{M\omega_0}{R}$$

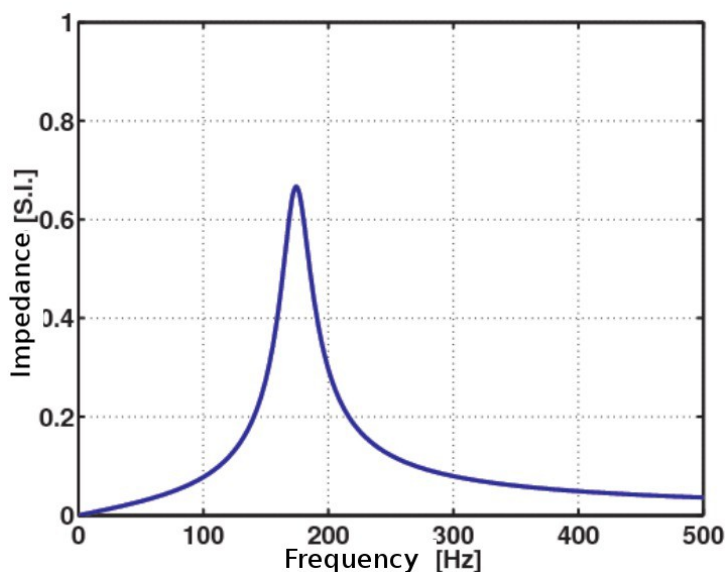

The mobility (or mechanical admittance) Y is maximum at the resonance. This therefore seems to be a more intuitive way of representing the system.

5. Choice of an analogy

The usual representations are dependent on the available measurement facilities: it is easy to estimate a mechanical displacement or an electrical voltage, without modification of the systems.

Because of this, the common representations associate a degree of freedom with an easy to measure quantity :

- The speed of a mass for a mechanical system.
- The voltage drop across a conductor in an electrical system.

The most natural analogy of a mechanical system is therefore the indirect analogy. However, it is more common to see equivalent networks represented using the direct analogy, mostly to avoid mixing the two analogies when coupling it to an acoustical system (which is naturally represented using the direct approach).

Equivalent network of a system

IV

Applications, example of a 2DoF (two degrees of freedom) system	21
Real system: Electrodynamic loudspeaker driver	21
Mechanical system	22
Direct approach: mechanical description	23
Direct approach: regrouping the terms	23
Direct approach: mechanical electrical analogy (1/2)	23
Direct approach: mechanical electrical analogy (2/2)	24
Mobility method: principle	24
Mobility method: mechanical schematic	25
Mobility method: conversion to the indirect analogy	25
Mobility method: conversion into a dual schematic	26

A. Applications, example of a 2DoF (two degrees of freedom) system

We will now see a simple and systematic way of transforming a mechanical schematic into its equivalent electrical network with the direct analogy.

This method will be illustrated by a real situational study, in which there are several degrees of freedom. This increased complexity will show the interest of a systematic method.

B. Real system: Electrodynamic loudspeaker driver

This video is taken during a measurement using a laser vibrometer. It represents the vibration (amplified to be visible) of a driver at a certain frequency which corresponds to two independent movements: on one hand the diaphragm, and on the other the surround suspension.

The diaphragm is light and rigid. It behaves like a rigid body.

The suspension is compliant and heavy: it flexes, and its inertia imposes a specific deformation.

The mobile part must be described by two separate masses.

C. Mechanical system

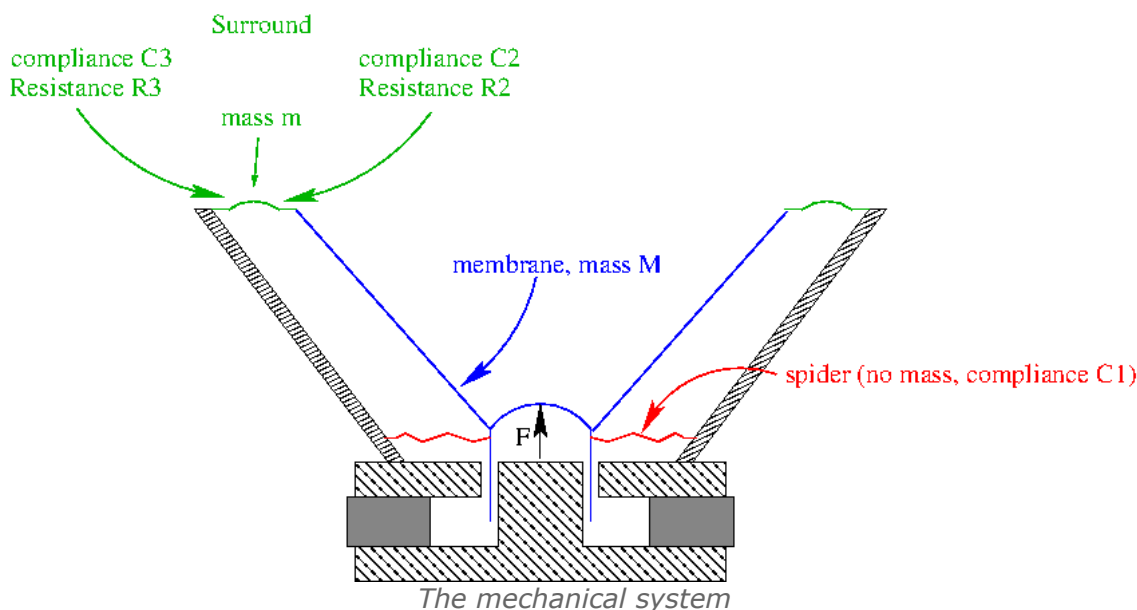

The mechanical characteristics of the surround (in green on figures) do not enable to assume it is a perfect compliance. This surround can be modeled as a Single Degree of Freedom (SDOF) system made of a mass m , two compliances C^2 and C^3 and two mechanical resistances R^2 and R^3 . This SDOF system is coupled with membrane movement.

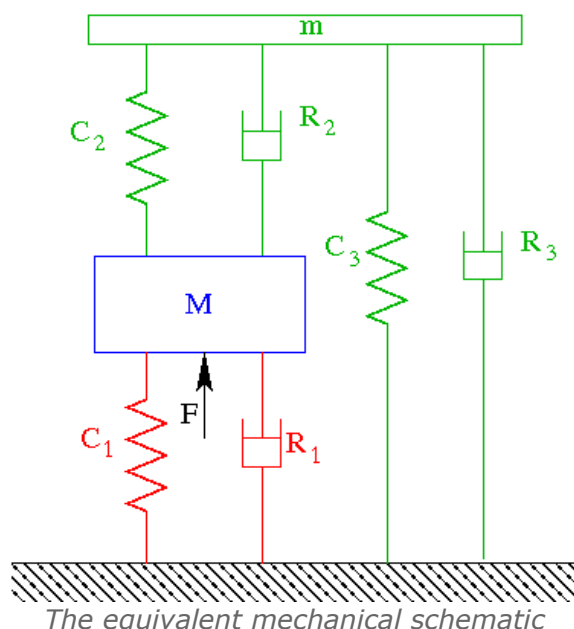

D. Direct approach: mechanical description

★ The classical way of describing this system consists in using the fundamental principle of dynamics, after having identified the different forces applied to each mass. This brings us to the following system of equations:

$$\begin{aligned} F - C_1\xi_1 - R_1\frac{d\xi_1}{dt} - C_2(\xi_1 - \xi_3) - R_2\left(\frac{d\xi_1}{dt} - \frac{d\xi_3}{dt}\right) &= M\frac{d\xi_1}{dt} \\ -C_3\xi_3 - R_3\frac{d\xi_3}{dt} - C_2(\xi_3 - \xi_1) - R_2\left(\frac{d\xi_3}{dt} - \frac{d\xi_1}{dt}\right) &= m\frac{d\xi_3}{dt} \end{aligned}$$

where ξ_1 and ξ_3 are the respective displacements of the masses M and m .

★ This group of coupled differential equations can be resolved using analytical or numerical methods.

E. Direct approach: regrouping the terms

★ The preceding equations can be reorganised by regrouping the terms that depend on the same masses, i.e., linked to the same degrees of freedom:

$$\begin{aligned} -F + M\frac{d\xi_1}{dt} + C_1\xi_1 + R_1\frac{d\xi_1}{dt} &= C_2(\xi_3 - \xi_1) + R_2\left(\frac{d\xi_3}{dt} - \frac{d\xi_1}{dt}\right) \\ m\frac{d\xi_3}{dt} + C_3\xi_3 + R_3\frac{d\xi_3}{dt} &= C_2(\xi_1 - \xi_3) + R_2\left(\frac{d\xi_1}{dt} - \frac{d\xi_3}{dt}\right) \end{aligned}$$

★ The rewriting shows the existence of three groups: two are linked to one degree of freedom (the terms with ξ_1 or ξ_3).

★ the third group is common (with a change of sign) to both equations, and describes their coupling (the term $\xi_3 - \xi_1$).

★ The representation of a system will therefore have two groups depending on the degrees of freedom, linked by a third which describes their coupling. Following the type of analogy used, the equivalent network describes these groups by the loops (direct analogy) or the branches (indirect analogy).

F. Direct approach: mechanical electrical analogy (1/2)

★ When using the direct analogy, the equivalent electrical network can be obtained by applying the following rules, which are based on the principles of this analogy:

- A loop, describing the fundamental principle of dynamics applied to a moving mass, corresponds to the degree of freedom associated with this mass.
- This loop is a closed circuit, with all the elements associated with the movement of the mass (including the applied exterior forces), in series.
- The coupling between the two degrees of freedom is represented by a branch that links the two loops. There are therefore three branches in parallel.

G. Direct approach: mechanical electrical analogy (2/2)

The construction of the network is illustrated in the following image:

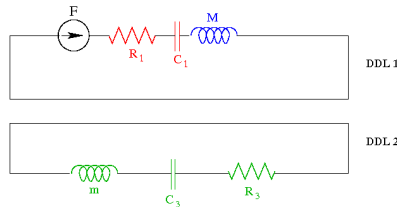

Two non coupled masses

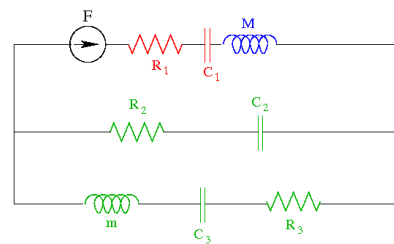

Two coupled masses

★ We can see that the topology of the electrical network is not the same as the mechanical one. This means that it is not always intuitive to go directly from the mechanical schematic to the electrical network. The risk of errors increases with the complexity of the system (increasing the degrees of freedom).

★ For those for which the above method does not seem practical, another approach exists: the "mobility" method.

H. Mobility method: principle

★ The mobility method consists in describing the mechanical system using the indirect analogy, which is easy to do, then converting the electronic circuit into the direct analogy.

★ there are three stages:

- Description of the system by its **complete** mechanical schematic.
- Obtaining the electrical circuit in the indirect analogy (topology of the mechanical schematic "respected" by the indirect analogy)
- Conversion to a "dual circuit" to obtain the electrical circuit in the direct analogy.

This method can be used for complex mechanical systems.

I. Mobility method: mechanical schematic

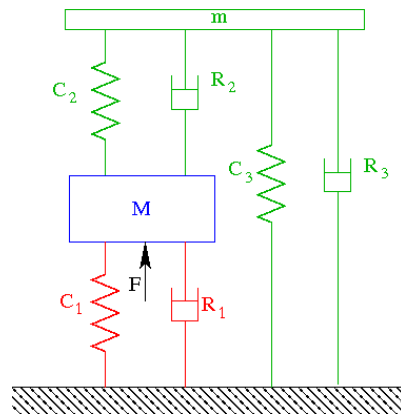

Equivalent mechanical schematic

New schematic with links between the masses and the stationary reference frame

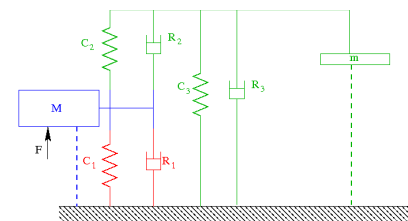

The mechanical schematic must be complete

- Each exterior force is linked to the reference frame
- This is particularly true for the "inertial forces" ($M_i \frac{dv}{dt}$)

J. Mobility method: conversion to the indirect analogy

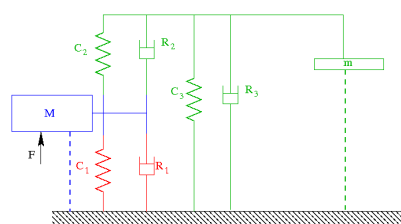

"Complete" mechanical schematic

Equivalent electrical circuit in the indirect analogy (admittance)

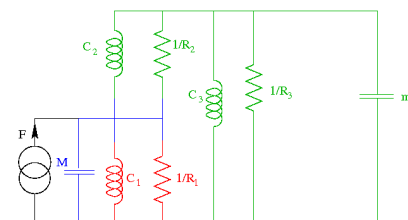

Masses of the mechanical schematic (nodes) \Leftrightarrow speeds

- The global structure is conserved
- The elements are thus converted one by one

K. Mobility method: conversion into a dual schematic

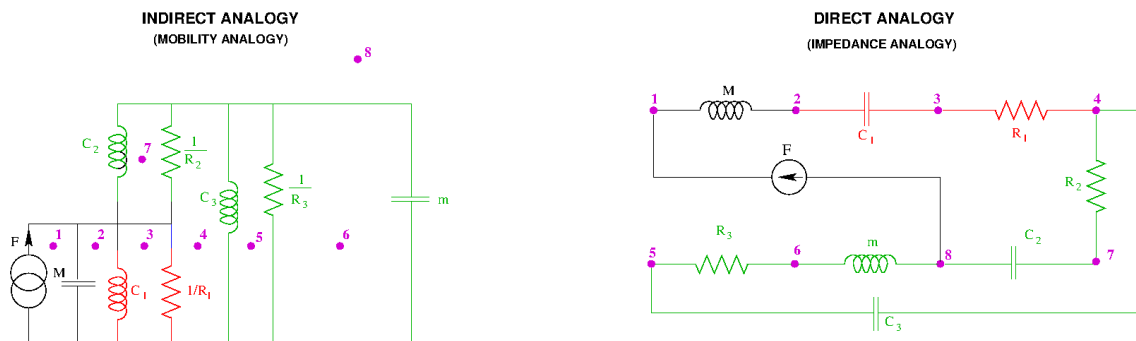

Every circuit has a "dual"

- To obtain the dual circuit, a point is placed in each loop, including the exterior loop (here number 8). These loops then become nodes when moving to the dual circuit.
- The elements shared between two independent loops are to be connected between the two corresponding nodes in the dual circuit, and since the change in analogy implies a change in the nature of the elements ; a capacitor C becomes a self C , a resistor $1/R$ becomes a resistor R , etc ...

Conclusion

V

Exit test	27
Exit test: answer	28
Bibliography	28

A. Exit test

Determine the equivalent electrical network of the following system (mechanical part of an accelerometer)

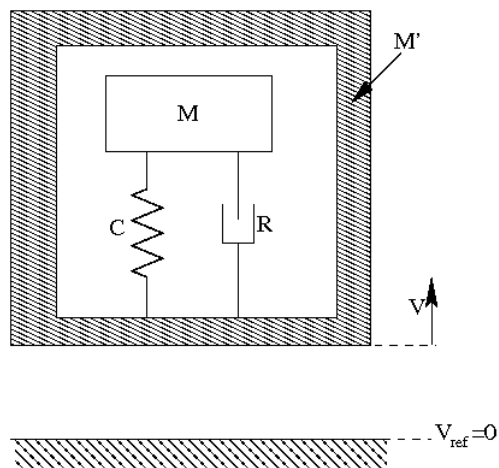

B. Exit test: answer

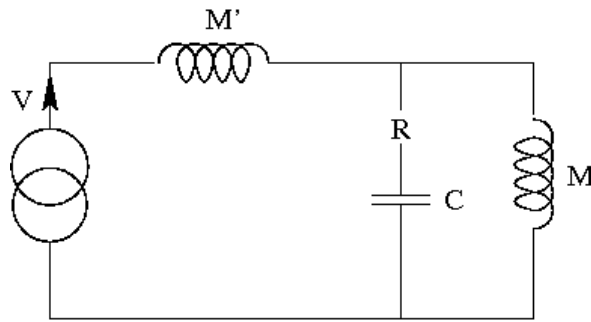

C. Bibliography

- [1] J. Merhaut, "Theory of electroacoustics", chapitre 1, Mc Graw-Hill, 1981.
- [2] M. Rossi, "Audio", chapitre 6, Presse Polytechniques et Universitaires Romandes, 2007 (in French)